



Nikon <sup>(th)</sup>  
100  
anniversary







Upright Microscope  
ECLIPSE  
*Ni/Ci*  
Accessories





# Contents





## Ni-E (Focusing stage type)

 Brightfield set .....1
 Epi-fluorescence set .....2
 DIC (Differential Interference Contrast) set .....3
 Epi-fluorescence and DIC set .....4





## Ni-E (Focusing nosepiece type)

 Multi-color fluorescent imaging set.....5
 Photoactivation imaging set .....6
 Simultaneous multichannel imaging set .....7





## Ni-U





 Brightfield set .....8
 Epi-fluorescence set .....9
 DIC (Differential Interference Contrast) set .....10
 Epi-fluorescence and DIC set .....11

## Ni-U

 Phase contrast set .....12
 Motorized module .....13
 Photoactivation imaging set .....14
 Simultaneous multichannel imaging set .....15

## Ci-E/Ci-L/Ci-S

 Brightfield set (Ci-E) .....16
 Brightfield set (Ci-L/Ci-S) .....17
 Epi-fluorescence set (Ci-E) .....18
 Epi-fluorescence set (Ci-L/Ci-S) .....19
 Phase contrast set .....20

 Tube/Port/TV-Tube/TV Adapter .....21
 Eyepiece/Substage/Stage .....22
 Condenser/Intermediate module/Other accessory .....23
 Teaching accessory .....24

# Ni-E brightfield set

- Ni-E (focusing stage type, motorized) set for brightfield observation
- Enables 2x to 100x observation by switching objectives with simple push-button operation.
- Two cameras can be mounted simultaneously.



	MBA91000	ECLIPSE Ni-E Main Body
1	MBD92100	NIE-CAM Contact Arm
2	MBB94510	NI-TT-E Motorized Quadrocular Tilting Tube
3	MBB96710	NI-RPZ-E Motorized DSC Zooming Port for Quadrocular Tube
	MBB94700	C-TAQ Tube Adapter for Quadrocular Tube
	MQD42070	C-Mount Adapter 0.7X
	MAK30100	CFI UW 10X Eyepiece (2 pcs.)
4	MBP98405	NI-N7-E Motorized Septuple Nosepiece
		Objectives
5	MBD93010	NI-SSR Substage for Rotatable/Motorized Stage
6	MBC91010	NIE-CSRR2 Right Handle Rotatable Ceramic Stage with Holder
7	MBL99800	NI-CUD-E Motorized Universal Condenser Dry
8	MBH99000	NI-CALN1 2-4X Auxiliary Lens for N1 Position
9	MBE95205	NI-LH Precentered Lamphouse
	MBF95400	NI-CTLA Control Box A
10	MQA21020	DS-L3 DS Camera Control Unit
	MQF52055	AC Adapter 2
		USB Cable

Option

11	MBC96100	NI-S-E Motorized XY Stage <sup>*1</sup>
	MBC96110	NI-SA Motorized XY Stage Adapter <sup>*2</sup>
12	MBF95130	NI-SJ Joystick for Motorized Stage <sup>*2</sup>
13	MBF95110	NI-ERG NI Ergo Controller <sup>*2*3</sup>
14	MBN98800	NI-ND-E Motorized ND Filter
15	MBF95420	NIE-CB Connector Box <sup>*4</sup>

\*1 NIE-CSRR2 Right Handle Rotatable Ceramic Stage with Holder can be used as an alternative.  
 \*2 For use with NI-S-E Motorized XY Stage  
 \*3 NI-SJ Joystick for Motorized Stage can be used as an alternative.  
 \*4 Required when using NI-S-E Motorized XY Stage or NI-ND-E Motorized ND Filter.

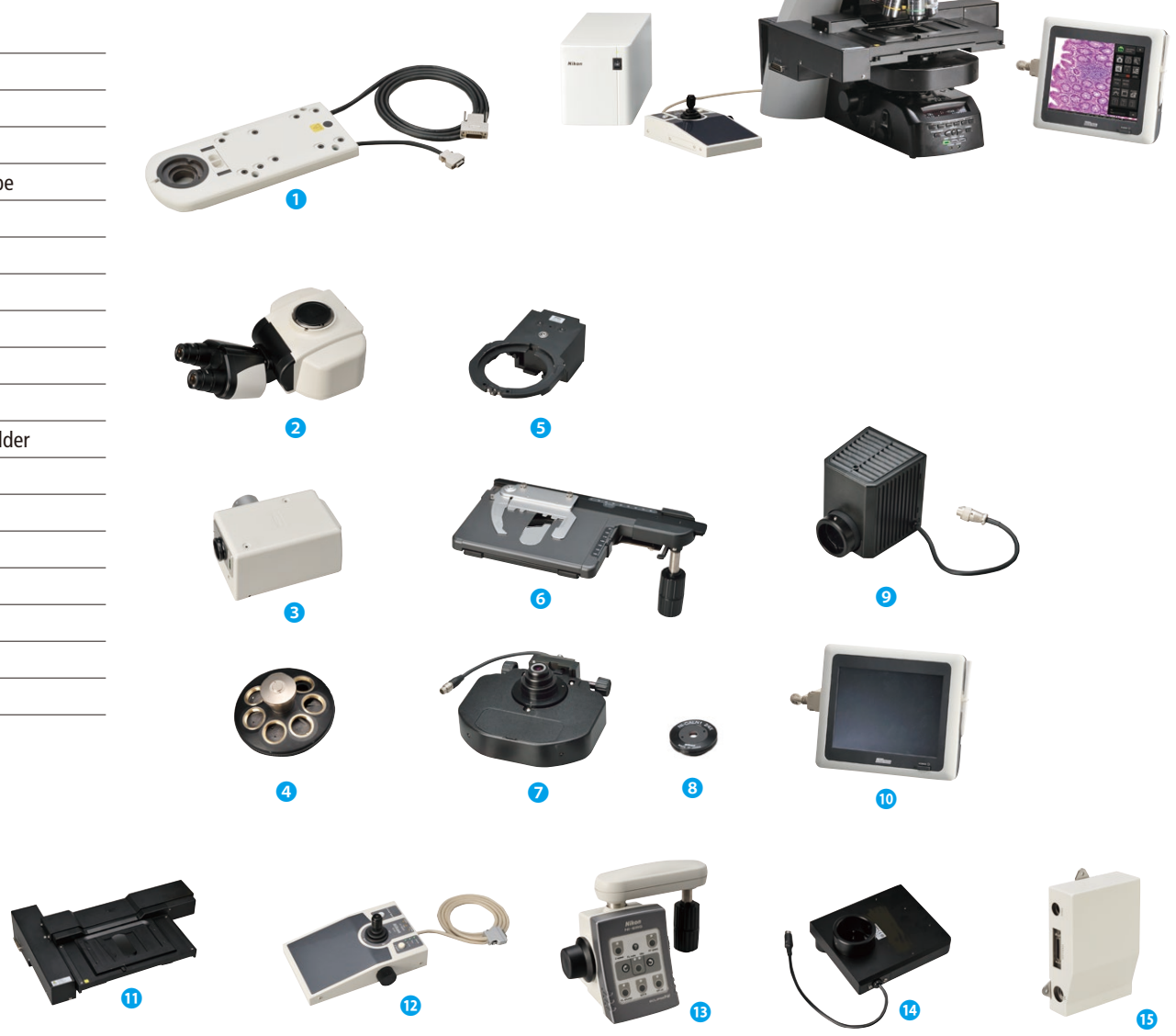

# Ni-E epi-fluorescence set.....2

- Ni-E (focusing stage type, motorized) set for epi-fluorescence observation
- Filter cubes can be switched with a simple push-button operation.
- Motorized condenser attachment enables 2x to 100x brightfield observation.
- Two cameras can be mounted simultaneously.



	MBA91000	ECLIPSE Ni-E Main Body
1	MBD92100	NIE-CAM Contact Arm
2	MBB94510	NI-TT-E Motorized Quadrocular Tilting Tube
3	MBB96710	NI-RPZ-E Motorized DSC Zooming Port for Quadrocular Tube
	MBB94700	C-TAQ Tube Adapter for Quadrocular Tube
	MQD42000	C-Mount TV Adapter A
	MAK30100	CFI UW 10X Eyepiece (2 pcs.)
4	MBE94300	NI-FLT6-E Motorized Epi-fluorescence Cube Turret
5	MBE94100	NI-FLEI EPI-Fluorescence Attachment
	-	FL Filter Cubes
	MBF72665	C-HGFIE HG Precentered Fiber Illumination Intensilight
	MBF72600	C-HGFIE-C HG Controller
	MBF71610	C-HGFIF15 HG Fiber
	MBF72311	C-HGFIB HG100W Adapter R
6	MBP98405	NI-N7-E Motorized Septuple Nosepiece Objectives
7	MBD93010	NI-SSR Substage for Rotatable /Motorized Stage
8	MBC91010	NIE-CSRR2 Right Handle Rotatable Ceramic Stage with Holder
9	MBL99800	NI-CUD-E Motorized Universal Condenser Dry
10	MBH99000	NI-CALN1 2-4X Auxiliary Lens for N1Position <sup>*1</sup>
	MBE95205	NI-LH Precentered Lamphouse
	MBF95400	NI-CTLA Control Box A
	MQA21020	DS-L3 DS Camera Control Unit
	MQF52055	AC Adapter 2
	-	USB Cable



### Option

11	MBN71930	D-FB Excitation Balancer <sup>*2</sup>
12	MBH70210	D-C PH-1 PH Module <sup>*3</sup>
13	MBH70220	D-C PH-2 PH Module <sup>*3</sup>
14	MBH70230	D-C PH-3 PH Module <sup>*3</sup>
15	MBH70250	D-C DF Dark Field Module <sup>*4</sup>

\*1 Required when using 2x and 4x objectives

\*2 For use in combination with multi-band filter cube

\*3 For use in combination with phase contrast objectives

\*4 Required for darkfield observation

- Ni-E (focusing stage type, motorized) set for DIC observation
- Simple push-button operation simultaneously switches objectives and optical modules within the condenser.
- Motorized condenser attachment enables 2x to 100x brightfield observation.
- Two cameras can be mounted simultaneously.

Ni-E (Focusing stage type)

	MBA91000	ECLIPSE Ni-E Main Body
1	MBD92100	NIE-CAM Contact Arm
2	MBB94510	NI-TT-E Motorized Quadrocular Tilting Tube
3	MBB96710	NI-RPZ-E Motorized DSC Zooming Port for Quadrocular Tube
	MBB94700	C-TAQ Tube Adapter for Quadrocular Tube
	MQD42070	C-Mount Adapter 0.7X
	MAK30100	CFI UW 10X Eyepiece (2 pcs.)
4	MBP98325	NI-ND6-E Motorized DIC Sextuple Nosepiece
5	-	D-C DIC Sliders
6	MBN74920	D-DA Analyzer Slider for DIC
7	MBN74960	D-LP Lambda Plate
		Objectives
8	MBD93010	NI-SSR Substage for Rotatable /Motorized Stage
9	MBC91010	NIE-CSRR2 Right Handle Rotatable Ceramic Stage with Holder
10	MBL99800	NI-CUD-E Motorized Universal Condenser Dry
11	MBH99000	NI-CALN1 2-4X Auxiliary Lens for N1 Position <sup>**2</sup>
12	MBH70200	D-C 2-4X Auxiliary Lens for N2 Position <sup>**3</sup>
13	MBH72300	D-C DIC N1 DRY DIC Module
14	MBH72310	D-C DIC N2 DRY DIC Module
15	MBN74940	D-DP DIC Rotatable Polarizer
	MBE95205	NI-LH Precentered Lamphouse
	MBF95400	NI-CTLA Control Box A
	MQA21020	DS-L3 DS Camera Control Unit
	MQF52055	AC Adapter 2
		USB Cable



Option

16	MBH70210	D-C PH-1 PH Module <sup>*4</sup>
17	MBH70220	D-C PH-2 PH Module <sup>*4</sup>
18	MBH70230	D-C PH-3 PH Module <sup>*4</sup>
19	MBH70250	D-C DF Dark Field Module <sup>*5</sup>



- \*1 Required when using 2x and 4x objectives
- \*2 Cannot be used when N1 Dry DIC Module is in use
- \*3 Cannot be used when N2 Dry DIC Module is in use
- \*4 For use in combination with phase contrast objectives
- \*5 Required for darkfield observation

# Ni-E epi-fluorescence and DIC set ..... 4-1

- Ni-E (focusing stage type, motorized) set for epi-fluorescence and DIC observation
- Filter cubes can be switched with simple push-button operation.
- Simple push-button operation simultaneously switches objectives and optical modules within the condenser.



	MBA91000	ECLIPSE Ni-E Main Body
1	MBD92100	NIE-CAM Contact Arm
2	MBB94510	NI-TT-E Motorized Quadrocular Tilting Tube
3	MBB96710	NI-RPZ-E Motorized DSC Zooming Port for Quadrocular Tube
	MBB94700	C-TAQ Tube Adapter for Quadrocular Tube
	MQD42000	C-Mount TV Adapter A
	MAK30100	CFI UW 10X Eyepiece (2 pcs.)
4	MBE94300	NI-FLT6-E Motorized Epi-fluorescence Cube Turret
5	MBE94100	NI-FLEI EPI-Fluorescence Attachment
6	MEN51980	TI-A DIC Analyzer Cube
	-	FL Filter Cubes
	MBF72665	C-HGFIE HG Precentered Fiber Illumination Intensilight
	MBF72600	C-HGFIE-C HG Controller
	MBF71610	C-HGFIF15 HG Fiber
	MBF72311	C-HGFIB HG100W Adapter R
7	MBP98325	NI-ND6-E Motorized DIC Sextuple Nosepiece
8	MBN74960	D-LP Lambda Plate
9	-	D-C DIC Sliders

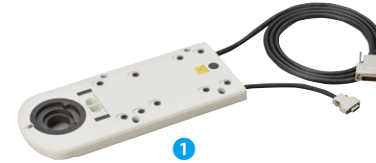

Ni-E (Focusing stage type)

	Objectives
10	MBD93010 NI-SSR Substage for Rotatable /Motorized Stage
11	MBC91010 NIE-CSRR2 Right Handle Rotatable Ceramic Stage with Holder
12	MBL99800 NI-CUD-E Motorized Universal Condenser Dry
13	MBH99000 NI-CALN1 2-4X Auxiliary Lens for N1 Position <sup>*1*2</sup>
14	MBH70200 D-C 2-4X AUXILIARY LENS Auxiliary Lens for N2 Position <sup>*1*3</sup>
15	MBH72300 D-C DIC N1 DRY DIC Module
16	MBH72310 D-C DIC N2 DRY DIC Module
17	MBN74940 D-DP DIC ROTATABLE POLARIZER
	MBE95205 NI-LH Precentered Lamphouse
	MBF95400 NI-CTLA Control Box A
	MQA21020 DS-L3 DS Camera Control Unit
	MQF52055 AC Adapter 2
	USB Cable

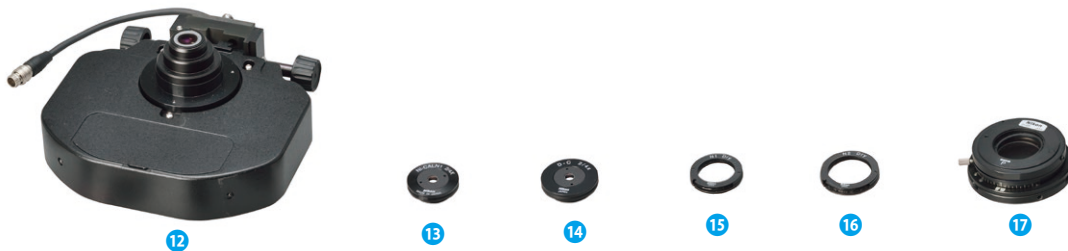

Option

18	MBN91920	NI-FA FL/DIC Analyzer <sup>*4</sup>
19	MBN71930	D-FB Excitation Balancer <sup>*5</sup>
20	MBH70210	D-C PH-1 PH Module <sup>*6</sup>
21	MBH70220	D-C PH-2 PH Module <sup>*6</sup>
22	MBH70230	D-C PH-3 PH Module <sup>*6</sup>
23	MBH70250	D-C DF Dark Field Module <sup>*7</sup>

\*1 Required when using 2x and 4x objectives  
 \*2 Cannot be used when N1 Dry DIC Module is in use  
 \*3 Cannot be used when N2 Dry DIC Module is in use  
 \*4 Required for epi-fluorescence DIC observation; should be manually inserted into optical path  
 \*5 For use in combination with multi-band filter cube  
 \*6 For use in combination with phase contrast objectives  
 \*7 Required for darkfield observation

- Ni-E (focusing nosepiece type, motorized) set for multi-color imaging
- Motorized excitation/barrier filter wheels enable multi-color fluorescence imaging.



	MBA91000	ECLIPSE Ni-E Main Body
1	MBD92200	NI-FNA Focusing Nosepiece Sub Arm
2	MXB22378	NI-AMSS Arm Spacer 49MM
3	MBD92100	NIE-CAM Contact Arm
4	MBB94510	NI-TT-E Motorized Quadrocular Tilting Tube
5	MBB96710	NI-RPZ-E Motorized DSC Zooming Port for Quadrocular Tube
	MBB94700	C-TAQ Tube Adapter for Quadrocular Tube
	MQD42000	C-Mount TV Adapter A
	MAK10100	CFI 10X Eyepiece (2 pcs.)
6	MBE94620	NI-BAW-E Motorized Barrier Filter Wheel
7	MBE94300	NI-FLT6-E Motorized Epi-fluorescence Cube Turret
8	MBE94100	NI-FLEI EPI-Fluorescence Attachment
	-	FL Filter Cubes
9	MEN51980	TI-A DIC Analyzer Cube
10	MEN71956	A1-FN1-IR Analyzer Block IR
11	MBE94610	NI-EXW-E Motorized Excitation Filter Wheel
12	MBE96000	NI-SH-E Motorized Shutter
	MBE96920	NI-SHCS Motorized Shutter Cable Short
	MBE96905	TI-SHAEP-I Motorized Shutter Adapter for Inverted Epi-FL
	MBF72665	C-HGFIE HG Precentered Fiber Illumination Intensilight
	MBF72600	C-HGFIE-C HG Controller
	MBF71610	C-HGFIF15 HG FIBER
	MBF72311	C-HGFIB HG100W Adapter R
13	MBP70100	FN-S2N 2 Place Sliding Nosepiece





	Objectives
-	D-C DIC Sliders
14	MBD93030 NI-SSF Substage for Focusing Nosepiece
	MBC96100 NI-S-E Motorized XY Stage
	MBC96110 NI-SA Motorized XY Stage Adapter
	MBF95130 NI-SJ Joystick for Motorized Stage
	MXB22406 NI-SH-D Dish Holder
15	MBL70100 FN-C LWD Condenser
16	MBH72300 D-C DIC N1 DRY DIC Module
17	MBH72310 D-C DIC N2 DRY DIC Module
18	MBH72100 FN-PT4X 4X Support Lens
19	MBN91930 NI-PT Polarizer Turret
20	MBN71946 FN-P Polarizer
21	MBN71960 FN-IRP IR Polarizer
	MBY10037 NI-IRLH Precentered IR Lamphouse
	MBF95400 NI-CTLA Control Box A
	MBF95420 NIE-CB Connector Box
	MQA21020 DS-L3 DS Camera Control Unit
	MQF52055 AC Adapter 2
	USB Cable

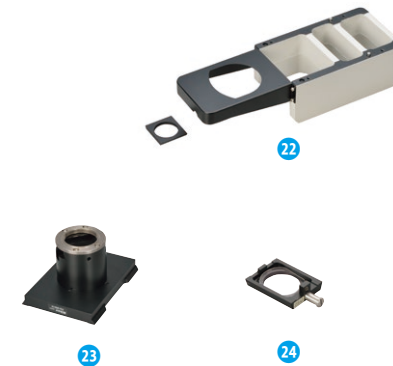

### Option

22	MXB22379	NI-AMSL Arm Spacer 74mm
23	MBP70110	FN-MN-H CFI 75 Holder
24	MBH76225	D-C DIC 25XI DIC Slider
25	MRD77220	CFI75 Apochromat 25XW MP
	MBC74001	FN-3PS2 FN1 Standard Stage
	MBC94100	NI-3PSA Adapter for FN1 Standard Stage
	MBN98800	NI-ND-E Motorized ND Filter
	MBE96900	NI-SHAEP-U Motorized Shutter Adapter for Upright Epi-FL

- Ni-E (focusing nosepiece type, motorized) set for photoactivation imaging.
- Enables photoactivation of a cell or a living organism, and image acquisition of its reaction.



	MBA91000	ECLIPSE Ni-E Main Body
1	MBD92200	NI-FNA Focusing Nosepiece Sub Arm
2	MXB22378	NI-AMSS Arm Spacer 49mm
3	MBD92100	NIE-CAM Contact Arm
	MBB94510	NI-TT-E Motorized Quadrocular Tilting Tube
	MBB96710	NI-RPZ-E Motorized DSC Zooming Port for Quadrocular Tube
	MBB94700	C-TAQ Tube Adapter for Quadrocular Tube
	MQD42000	C-Mount TV Adapter A
	MAK10100	CFI 10X Eyepiece (2 pcs.)
4	MBE94300	NI-FLT6-E Motorized Epi-fluorescence Cube Turret (2 Units)
5	MBE94800	NI-PAU Ni Photoactivation Unit
6	MBE94100	NI-FLEI EPI-Fluorescence Attachment
	-	FL Filter Cubes
7	MEN51980	TI-A DIC Analyzer Cube
8	MEN71956	A1-FN1-IR Analyzer Block IR
	MBF72665	C-HGFIE HG Precentered Fiber Illumination Intensilight
	MBF72600	C-HGFIE-C HG Controller
	MBF71610	C-HGFIF15 HG FIBER
	MBF72311	C-HGFIB HG100W Adapter R
9	MBP70100	FN-S2N 2 Place Sliding Nosepiece

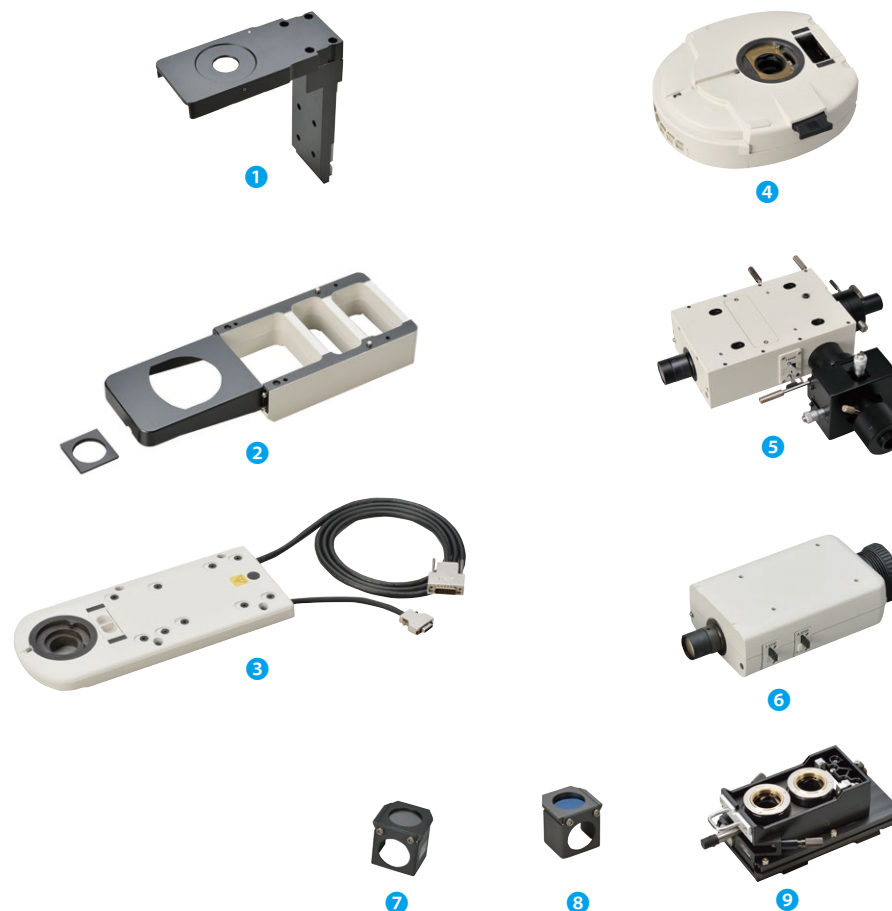

	Objectives
-	D-C DIC Sliders
10	MBD93030 NI-SSF Substage for Focusing Nosepiece
	MBC96100 NI-S-E Motorized XY Stage
	MBC96110 NI-SA Motorized XY Stage Adapter
	MBF95130 NI-SJ Joystick for Motorized Stage
	MXB22406 NI-SH-D Dish Holder
11	MBL70100 FN-C LWD Condenser
12	MBH72300 D-C DIC N1 DRY DIC Module
13	MBH72310 D-C DIC N2 DRY DIC Module
14	MBH72100 FN-PT4X 4X Support Lens
15	MBN91930 NI-PT Polarizer Turret
16	MBN71946 FN-P Polarizer
17	MBN71960 FN-IRP IR Polarizer
	MBY10037 NI-IRLH Precentered IR Lamphouse
	MBF95400 NI-CTLA Control Box A
	MBF95420 NIE-CB Connector Box
	MQA21020 DS-L3 DS Camera Control Unit
	MQF52055 AC Adapter 2
	USB Cable

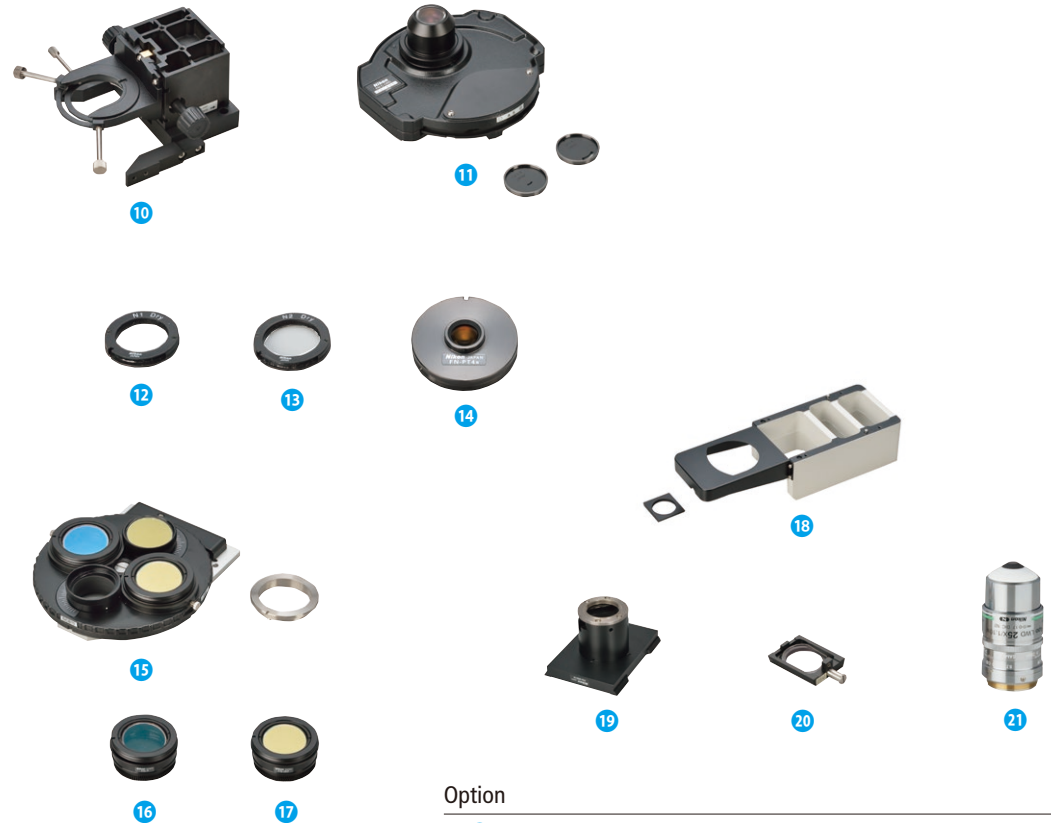

Option

18	MXB22379	NI-AMSL Arm Spacer 74mm
19	MBP70110	FN-MN-H CFI 75 Holder
20	MBH76225	D-C DIC 25XI DIC Slider
21	MRD77220	CFI75 Apochromat 25XW MP
	MBG74001	FN-3PS2 FN1 Standard Stage
	MBC94100	NI-3PSA Adapter for FN1 Standard Stage

- Ni-E (focusing nosepiece type, motorized) set for multi-channel, simultaneous imaging.
- Enables simultaneous acquisition of fluorescence images in two different wavelengths.



	MBA91000	ECLIPSE Ni-E Main Body
1	MBD92200	NI-FNA Focusing Nosepiece Sub Arm
2	MXB22378	NI-AMSS Arm Spacer 49MM
3	MBD92100	NIE-CAM Contact Arm
4	MBB94510	NI-TT-E Motorized Quadrocular Tilting Tube
5	MBB96710	NI-RPZ-E Motorized DSC Zooming Port for Quadrocular Tube
	MBB94700	C-TAQ Tube Adapter for Quadrocular Tube
	MQD42000	C-Mount TV Adapter A
	MAK10100	CFI 10X Eyepiece (2 pcs.)
6	MBE94300	NI-FLT6-E Motorized Epi-fluorescence Cube Turret (2 Units)
7	MBE94200	NI-BPU Back Port Unit
8	MXA22128	C-FL2 Blank Cube
9	MBE49310	C-FLF Mirror Cube
10	MBE49300	C-FLF FRET Cube
11	MBB96900	NI-RPS DSC Support Column
12	MBB96910	NI-RPSAA DSC Adapter A (for the Andor iXon Series)
13	MBE94100	NI-FLEI EPI-Fluorescence Attachment
	-	FL Filter Cubes
14	MEN51980	TI-A DIC Analyzer Cube
15	MEN71956	A1-FN1-IR Analyzer Block IR
	MBF72665	C-HGFIE HG Precentered Fiber Illumination Intensilight
	MBF72600	C-HGFIE-C HG Controller
	MBF71610	C-HGFIF15 HG Fiber
	MBF72311	C-HGFIB HG100W Adapter R
16	MBP70100	FN-S2N 2 Place Sliding Nosepiece



	Objectives
-	D-C DIC Sliders
17	MBD93030 NI-SSF Substage for Focusing Nosepiece
	MBC96100 NI-S-E Motorized XY Stage
	MBC96110 NI-SA Motorized XY Stage Adapter
	MBF95130 NI-SJ Joystick for Motorized Stage
	MXB22406 NI-SH-D Dish Holder
18	MBL70100 FN-C LWD Condenser
19	MBH72300 D-C DIC N1 DRY DIC Module
20	MBH72310 D-C DIC N2 DRY DIC Module
21	MBH72100 FN-PT4X 4X Support Lens
22	MBN91930 NI-PT Polarizer Turret
23	MBN71946 FN-P Polarizer
24	MBN71960 FN-IRP IR Polarizer
	MBY10037 NI-IRLH Precentered IR Lamphouse
	MBF95400 NI-CTLA Control Box A
	MBF95420 NIE-CB Connector Box
	MQA21020 DS-L3 DS Camera Control Unit
	MQF52055 AC Adapter 2
	USB Cable



Option

25	MXB22379	NI-AMSL Arm Spacer 74mm
26	MBB96920	NI-RPSAB DSC Adapter B (for the Roper Cascade Series)
27	MBP70110	FN-MN-H CFI 75 Holder
28	MBH76225	D-C DIC 25XI DIC Slider
29	MRD77220	CFI75 Apochromat 25XW MP
	MBC74001	FN-3PS2 FN1 Standard Stage
	MBC94100	NI-3PSA Adapter for FN1 Standard Stage

• Basic set for brightfield observation



6

7



8



9



10



11

For First-order Red Compensation



12



13



14

For Simple Polarization



15



16



17

	MBA92010	ECLIPSE Ni-U Main Body
1	MBD92000	NI-SAM Standard Arm
2	MBB93800	C-TE2 Ergonomic Binocular Tube
3	MBB96800	C-TEP2 DSC Port for Ergonomic Binocular Tube
	MAK30100	CFI UW 10X Eyepiece (2 pcs.)
4	MBP71315	C-N6 ESD Sextuple Nosepiece ESD
		Objectives
5	MBC91110	C-SR2S Right Handle Stage with 2SHolder
6	MBD93000	NI-SS Substage
7	MBD94000	NI-CH Condenser Holder
8	MBL71200	C-C Achromat Condenser NA 0.9
9	MBE95205	NI-LH Precentered Lamphouse

### Option

10	MBB93110	C-TT Trinocular Tube T
11	MBB73520	Y-TV TV Tube
	MQD42070	C-Mount Adapter 0.7X
	MBP71325	C-N6A Sextuple Nosepiece with Analyzer Slot
12	MBB75380	C-TP Polarizer for First-order Red Compensation
13	MBN91921	C-AS Analyzer Slider for First-order Red Compensation <sup>*1,2</sup>
14	MBB75360	C-IA Analyzer Tube for First-order Red Compensation
15	MBB75370	C-SP Polarizer for Simple Polarization
16	MBN74925	D-SA Analyzer Slider for Simple Polarization <sup>*1,3</sup>
17	MBB75350	C-ISA Analyzer Tube for Simple Polarization

\*1 For use in combination with C-N6A Sextuple Nosepiece with Analyzer Slot.

\*2 C-IA Analyzer Tube for First-order Red Compensation can be used as an alternative.

\*3 C-ISA Analyzer Tube for Simple Polarization can be used as an alternative.

• Ni-U set for epi-fluorescence observation

MBA92010	ECLIPSE Ni-U Main Body
MBD92000	NI-SAM Standard Arm
MBB93110	C-TT Trinocular Tube T
MBB73520	Y-TV TV Tube
MQD42000	C-Mount TV Adapter A
MAK30100	CFI UW 10X Eyepiece (2 pcs.)
1	MBE94500 NI-FLT6 Epi-fluorescence Cube Turret
2	MBE94100 NI-FLEI EPI-Fluorescence Attachment
-	FL Filter Cubes
3	MBF72655 C-HGFI HG Precentered Fiber Illumination Intensilight
	MBF71610 C-HGFIF15 HG Fiber
	MBF72311 C-HGFIB HG100W Adapter R
4	MBP71315 C-N6 ESD Sextuple Nosepiece ESD Objectives
5	MBC91110 C-SR2S Right Handle Stage with 2SHolder
6	MBD93000 NI-SS Substage
7	MBD94000 NI-CH Condenser Holder
8	MBL71200 C-C Achromat Condenser NA 0.9
	MBE95205 NI-LH Precentered Lamphouse

Option

9	MBN71930 D-FB Excitation Balancer**1
---	--------------------------------------

\*1 For use in combination with multi-band filter cube



- Ni-U set for DIC observation



	MBA92010	ECLIPSE Ni-U Main Body
	MBD92000	NI-SAM Standard Arm
	MBB93110	C-TT Trinocular Tube T
	MBB73520	Y-TV TV Tube
	MQD42070	C-Mount Adapter 0.7X
	MAK30100	CFI UW 10X Eyepiece (2 pcs.)
1	MBP73325	D-ND6 DIC Sextuple Nosepiece
2	MBN74920	D-DA Analyzer Slider for DIC
3	MBN74960	D-LP Lambda Plate
4	-	D-C DIC Sliders
		Objectives
5	MBC91110	C-SR2S Right Handle Stage with 2SHolder
6	MBD93000	NI-SS Substage
7	MBD94000	NI-CH Condenser Holder
8	MBL99000	NI-CUD Universal Condenser Dry
9	MBH99000	NI-CALN1 2-4X Auxiliary Lens for N1 Position <sup>*1*2</sup>
10	MBH70200	D-C 2-4X Auxiliary Lens for N2 Position <sup>*1*3</sup>
11	MBH72300	D-C DIC N1 DRY DIC Module
12	MBH72310	D-C DIC N2 DRY DIC Module
13	MBN74940	D-DP DIC Rotatable Polarizer
	MBE95205	NI-LH Precentered Lamphouse

Option

14	MBH70210	D-C PH-1 PH Module <sup>*4</sup>
15	MBH70220	D-C PH-2 PH Module <sup>*4</sup>
16	MBH70230	D-C PH-3 PH Module <sup>*4</sup>
17	MBH70250	D-C DF Dark Field Module <sup>*5</sup>

\*1 Required when using 2x and 4x objectives

\*2 Cannot be used when N1 Dry DIC Module is in use

\*3 Cannot be used when N2 Dry DIC Module is in use

\*4 For use in combination with phase contrast objectives

\*5 Required for darkfield observation





• Ni-U set for epi-fluorescence and DIC observation

	MBA92010	ECLIPSE Ni-U Main Body
	MBD92000	NI-SAM Standard Arm
	MBB93110	C-TT Trinocular Tube T
	MBB73520	Y-TV TV Tube
	MQD42000	C-Mount TV Adapter A
	MAK30100	CFI UW 10X Eyepiece (2 pcs.)
1	MBE94500	NI-FLT6 Epi-fluorescence Cube Turret
2	MBE94100	NI-FLEI EPI-Fluorescence Attachment
3	MBN91920	NI-FA FL/DIC Analyzer
-	-	FL Filter Cubes
4	MBF72655	C-HGFI HG Precentered Fiber Illumination Intensilight
	MBF71610	C-HGFIF15 HG Fiber
	MBF72311	C-HGFIB HG100W Adapter R
5	MBP73325	D-ND6 DIC Sextuple Nosepiece
6	MBN74960	D-LP Lambda Plate
7	-	D-C DIC Sliders
		Objectives
	MBC91110	C-SR2S Right Handle Stage with 2SHolder
	MBD93000	NI-SS Substage
	MBD94000	NI-CH Condenser Holder
8	MBL99000	NI-CUD Universal Condenser Dry
9	MBH99000	NI-CALN1 2-4X Auxiliary Lens for N1Position <sup>*1*2</sup>
10	MBH70200	D-C 2-4X Auxiliary Lens for N2 Position <sup>*1*3</sup>
11	MBH72300	D-C DIC N1 DRY DIC Module
12	MBH72310	D-C DIC N2 DRY DIC Module
13	MBN74940	D-DP DIC Rotatable Polarizer
	MBE95205	NI-LH Precentered Lamphouse



Option

14	MBN71930	D-FB Excitation Balancer <sup>*4</sup>
15	MBH70210	D-C PH-1 PH Module <sup>*5</sup>
16	MBH70220	D-C PH-2 PH Module <sup>*5</sup>
17	MBH70230	D-C PH-3 PH Module <sup>*5</sup>
18	MBH70250	D-C DF Dark Field Module <sup>*6</sup>

- \*1 Required when using 2x and 4x objectives
- \*2 Cannot be used when N1 Dry DIC Module is in use
- \*3 Cannot be used when N2 Dry DIC Module is in use
- \*4 For use in combination with multi-band filter cube
- \*5 For use in combination with phase contrast objectives
- \*6 Required for darkfield observation

- Ni-U set for phase contrast observation



	MBA92010	ECLIPSE Ni-U Main Body
1	MBD92000	NI-SAM Standard Arm
2	MBB93110	C-TT Trinocular Tube T
3	MBB73520	Y-TV TV Tube
	MQD42070	C-Mount Adapter 0.7X
	MAK30100	CFI UW 10X Eyepiece (2 pcs.)
4	MAK85000	C-CT Centering Telescope with UW Adapter
5	MBP71315	C-N6 ESD Sextuple Nosepiece ESD
		Objectives
6	MBC91110	C-SR2S Right Handle Stage with 2SHolder
7	MBD93000	NI-SS Substage
8	MBD94000	NI-CH Condenser Holder
9	MBL73100	C-C Phase Contrast Turret Condenser
10	MBE95205	NI-LH Precentered Lamphouse



1



2



3



4



5



6

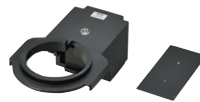

7



8



9



10

- Accessories for the Ni-U microscope, such as motorized epi-fluorescence cube turrets, motorized nosepieces and motorized shutters (including intelligent types).



1	MBD92110	NIU-CAM Contact Arm
2	MBF95410	NI-CTLB Control Box B
3	MBF95420	NIE-CB Connector Box
4	MBF95120	NI-SRCP Simple Remote Control Pad
5	MQA21020	DS-L3 DS Camera Control Unit
	MQF52055	AC Adapter 2
	MXA22113	C-CTC Camera Trigger Cable U3/L3
	MEF51001	TI-100WRC 100W Lamphouse Remote Cable
6	MBP98405	NI-N7-E Motorized Septuple Nosepiece
7	MBP99405	NI-N7-I Intelligent Septuple Nosepiece
8	MBP98325	NI-ND6-E Motorized DIC Sextuple Nosepiece
9	MBP99325	NI-ND6-I Intelligent DIC Sextuple Nosepiece
10	MBE94300	NI-FLT6-E Motorized Epi-fluorescence Cube Turret
11	MBE94400	NI-FLT6-I Intelligent Epi-fluoresce Cube Turret
12	MBE96000	NI-SH-E Motorized Shutter
	MBE96930	NI-SHCL Motorized Shutter Cable Long
	MBE96900	NI-SHAEP-U Motorized Shutter Adapter for Upright Epi-FL <sup>*1</sup>
	MBE96910	NI-SHAD1 Motorized Shutter Adapter for Dia-Illumination <sup>*2</sup>



\*1 Required for attaching the NI-SH-E Motorized Shutter to the NI-FLEI EPI-Fluorescence Attachment.

\*2 Required for attaching the NI-SH-E Motorized Shutter to the diasopic illumination unit.

• Attaching the photoactivation unit to the Ni-U microscope also enables photoactivation imaging.

	MBA92010	ECLIPSE Ni-U Main Body
1	MBD92110	NIU-CAM Contact Arm
2	MBB94521	NI-TT Quadrocular Tilting Tube
3	MBB96721	NI-RPZ DSC Zooming Port for Quadrocular Tube
	MBB94700	C-TAQ Tube Adapter for Quadrocular Tube
	MQD42000	C-Mount TV Adapter A
	MAK10100	CFI 10X Eyepiece (2 pcs.)
	MBE94500	NI-FLT6 Epi-fluorescence Cube Turret
	MBE94100	NI-FLEI EPI-Fluorescence Attachment
4	MBE94300	NI-FLT6-E Motorized Epi-fluorescence Cube Turret
5	MBE94800	NI-PAU Ni Photoactivation Unit
	-	FL Filter Cubes
	MBF72665	C-HGFIE HG Precentered Fiber Illumination Intensilight
	MBF72600	C-HGFIE-C HG Controller
	MBF71610	C-HGFIF15 HG Fiber
	MBF72311	C-HGFIB HG100W Adapter R
6	MBP98325	NI-ND6-E Motorized DIC Sextuple Nosepiece
7	MBN91920	NI-FA FL/DIC Analyzer
8	MBN74960	D-LP Lambda Plate
9	-	D-C DIC Sliders

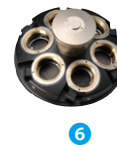
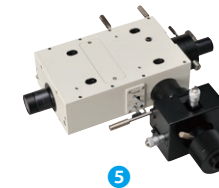
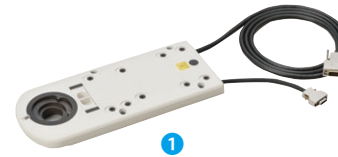

	Objectives
MBC91110	C-SR2S Right Handle Stage with 2SHolder
MBD93000	NI-SS Substage
MBD94000	NI-CH Condenser Holder
10	MBL99000 NI-CUD Universal Condenser Dry
11	MBH99000 NI-CALN1 2-4X Auxiliary Lens for N1Position <sup>*1*2</sup>
12	MBH70200 D-C 2-4X Auxiliary Lens for N2 Position <sup>*1*3</sup>
13	MBH72300 D-C DIC N1 DRY DIC Module
14	MBH72310 D-C DIC N2 DRY DIC Module
15	MBN74940 D-DP DIC Rotatable Polarizer
16	MBF95410 NI-CTLB Control Box B
17	MBF95120 NI-SRCP Simple Remote Control Pad
MQA21020	DS-L3 DS Camera Control Unit
MQF52055	AC Adapter 2
MXA22113	C-CTC Camera Trigger Cable U3/L3
MEF51001	TI-100WRC 100W Lamphouse Remote Cable
MBE95205	NI-LH Precentered Lamphouse



10



11



12



13



14



21

18

19

20



15



16



17

### Option

18	MBH70210	D-C PH-1 PH Module <sup>*4</sup>
19	MBH70220	D-C PH-2 PH Module <sup>*4</sup>
20	MBH70230	D-C PH-3 PH Module <sup>*4</sup>
21	MBH70250	D-C DF Dark Field Module <sup>*5</sup>

\*1 Required when using 2x and 4x objectives

\*2 Cannot be used when N1 Dry DIC Module is in use

\*3 Cannot be used when N2 Dry DIC Module is in use

\*4 For use in combination with phase contrast objectives

\*5 Required for darkfield observation

• Attaching the back port unit to the Ni-U microscope also enables simultaneous multichannel imaging.

	MBA92010	ECLIPSE Ni-U Main Body
1	MBD92110	NIU-CAM Contact Arm
	MBB93110	C-TT Trinocular Tube T
	MBB73520	Y-TV TV Tube
	MQD42000	C-Mount TV Adapter A
	MAK10100	CFI 10X Eyepiece (2 pcs.)
2	MBE94500	NI-FLT6 Epi-fluorescence Cube Turret
3	MBE94200	NI-BPU Back Port Unit
4	MXA22128	C-FL2 Blank Cube
5	MBE49310	C-FLF Mirror Cube
6	MBE49300	C-FLF FRET Cube
7	MBB96900	NI-RPS DSC Support Column
8	MBB96910	NI-RPSAA DSC Adapter A (for the Andor iXon Series)
9	MBE94300	NI-FLT6-E Motorized Epi-fluorescence Cube Turret
10	MBE94100	NI-FLEI EPI-Fluorescence Attachment
-		FL Filter Cubes
	MBF72665	C-HGFIE HG Precentered Fiber Illumination Intensilight
	MBF72600	C-HGFIE-C HG Controller
	MBF71610	C-HGFIF15 HG FIBER
	MBF72311	C-HGFIB HG100W Adapter R
11	MBP98325	NI-ND6-E Motorized DIC Sextuple Nosepiece
12	MBN91920	NI-FA FL/DIC Analyzer
13	MBN74960	D-LP Lambda Plate
14	-	D-C DIC Sliders



	Objectives
MBC91110	C-SR2S Right Handle Stage with 2SHolder
MBD93000	NI-SS Substage
MBD94000	NI-CH Condenser Holder
15 MBL99000	NI-CUD Universal Condenser Dry
16 MBH99000	NI-CALN1 2-4X Auxiliary Lens for N1 Position <sup>*1*2</sup>
17 MBH70200	D-C 2-4X Auxiliary Lens for N2 Position <sup>*1*3</sup>
18 MBH72300	D-C DIC N1 DRY DIC Module
19 MBH72310	D-C DIC N2 DRY DIC Module
20 MBN74940	D-DP DIC Rotatable Polarizer
21 MBF95410	NI-CTLB Control Box B
22 MBF95120	NI-SRCP Simple Remote Control Pad
MQA21020	DS-L3 DS Camera Control Unit
MQF52055	AC Adapter 2
MXA22113	C-CTC Camera Trigger Cable U3/L3
MEF51001	TI-100WRC 100W Lamphouse Remote Cable
MBE95205	NI-LH Precentered Lamphouse



### Option

23	MBB96920	NI-RPSAB DSC Adapter B (for the Roper Cascade Series)
24	MBH70210	D-C PH-1 PH Module <sup>*4</sup>
25	MBH70220	D-C PH-2 PH Module <sup>*4</sup>
26	MBH70230	D-C PH-3 PH Module <sup>*4</sup>
27	MBH70250	D-C DF Dark Field Module <sup>*5</sup>

\*1 Required when using 2x and 4x objectives

\*2 Cannot be used when N1 Dry DIC Module is in use

\*3 Cannot be used when N2 Dry DIC Module is in use

\*4 For use in combination with phase contrast objectives

\*5 Required for darkfield observation

- Ci-E set for brightfield observation.

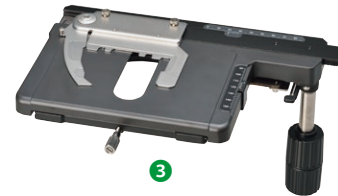

For First-order Red Compensation



For Simple Polarization



	MBA93000	ECLIPSE Ci-E Main Body
1	MBB93800	C-TE2 Ergonomic Binocular Tube
2	MBB96800	C-TEP2 DSC Port for Ergonomic Binocular Tube
	MAK10100	CFI 10X Eyepiece (2 pcs.)
		Objectives
3	MBC91110	C-SR2S Right Handle Stage with 2SHolder
	MBL99300	CI-C-E Motorized Swing-out Condenser

Option

4	MBP91705	CI-NS Spacer for Nosepiece
5	MBN97000	CI-FCH Filter Cassette Holder
	MXA22122	CI-IRC IR Cut Filter for Ci
6	MBB75360	C-IA Analyzer Tube for First-order Red Compensation
7	MBB75380	C-TP Polarizer for First-order Red Compensation
8	MBB75350	C-ISA Analyzer Tube for Simple Polarization
9	MBB75370	C-SP Polarizer for Simple Polarization



• Ci-L/Ci-S set for brightfield observation.



	MBA94010	ECLIPSE Ci-S Main Body
	MBA95000	ECLIPSE Ci-L Main Body
1	MBB93800	C-TE2 Ergonomic Binocular Tube
2	MBB96800	C-TEP2 DSC Port for Ergonomic Binocular Tube
	MAK10100	CFI 10X Eyepiece (2 pcs.)
3	MBP71315	C-N6 ESD Sextuple Nosepiece ESD
		Objectives
4	MBC91110	C-SR2S Right Handle Stage with 2SHolder
5	MBL71100	C-C Abbe Condenser NA 0.9

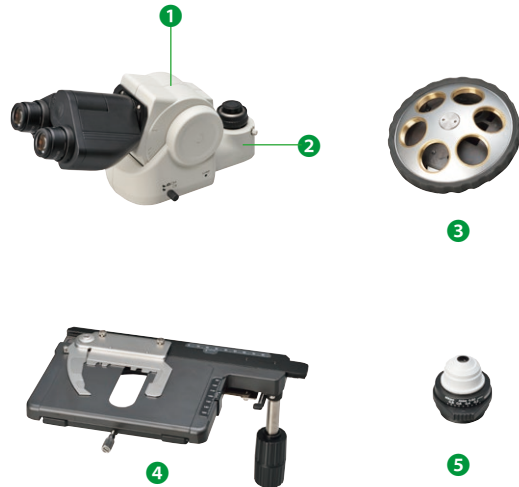

For First-order Red Compensation

For Simple Polarization

Option

6	MBB92100	C-TB Binocular Tube
	MBP71325	C-N6A Sextuple Nosepiece with Analyzer Slot
7	MBP91705	CI-NS Spacer for Nosepiece
8	MBN97000	CI-FCH Filter Cassette Holder
	MXA22122	CI-IRC IR Cut Filter for Ci
	MBP71325	C-N6A Sextuple Nosepiece with Analyzer Slot
9	MBB75380	C-TP Polarizer for First-order Red Compensation
10	MBN91921	C-AS Analyzer Slider for First-order Red Compensation <sup>*1*2</sup>
11	MBB75360	C-IA Analyzer Tube for First-order Red Compensation
12	MBB75370	C-SP Polarizer for Simple Polarization
13	MBN74925	D-SA Analyzer Slider for Simple Polarization <sup>*1*3</sup>
14	MBB75350	C-ISA Analyzer Tube for Simple Polarization

\*1 For use in combination with C-N6A Sextuple Nosepiece with Analyzer Slot.

\*2 C-IA Analyzer Tube for First-order Red Compensation can be used as an alternative.

\*3 C-ISA Analyzer Tube for Simple Polarization can be used as an alternative.

• Ci-E set for epi-fluorescence observation.

	MBA93000	ECLIPSE Ci-E Main Body
1	MBB93800	C-TE2 Ergonomic Binocular Tube
2	MBB96800	C-TEP2 DSC Port for Ergonomic Binocular Tube
	MAK10100	CFI 10X Eyepiece (2 pcs.)
3	MBE94310	CI-FL Epi-fluorescence Attachment
4	-	Filter Cubes
5	MBF72655	C-HGFI HG Precentered Fiber Illumination Intensilight
6	MBF71610	C-HGFIF15 HG Fiber
7	MBF72311	C-HGFIB HG100W Adapter R
		Objectives
8	MBC91110	C-SR2S Right Handle Stage with 2SHolder
	MBL99300	CI-C-E Motorized Swing-out Condenser

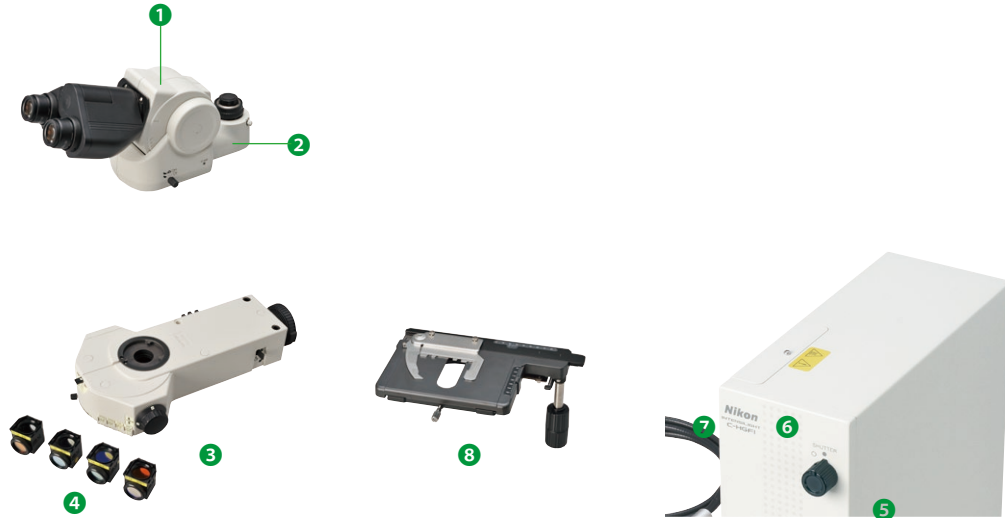

### Option

9	MBB93100	C-TF Trinocular Tube F
10	MBB93110	C-TT Trinocular Tube T
	MBB73520	Y-TV TV Tube
	MQD42000	C-mount TV Adapter A
11	MBE25301	Lamphouse HMX-3B
12	MBF33342	Mercury Lamp Socket S 100W BL
13	MBE75010	C-FC Epi FL Collector Lens
14	MBF12321	C-SHG1 Power Supply for HG 100W
15	MBE75060	C-FC Epi-FL Centering Tool
16	MBE74100	D-FL Epi-fluorescence Attachment*

\* Up to 6 filter cubes can be attached.

• Ci-L/Ci-S set for epi-fluorescence observation.

	MBA95000	ECLIPSE Ci-L Main Body
	MBA94010	ECLIPSE Ci-S Main Body
①	MBB93800	C-TE2 Ergonomic Binocular Tube
②	MBB96800	C-TEP2 DSC Port for Ergonomic Binocular Tube
	MAK10100	CFI 10X Eyepiece (2 pcs.)
③	MBE94310	CI-FL Epi-fluorescence Attachment
④	-	Filter Cubes
⑤	MBF72655	C-HGFI HG Precentered Fiber Illumination Intensilight
⑥	MBF71610	C-HGFIF15 HG Fiber
⑦	MBF72311	C-HGFIB HG100W Adapter R
	MBP71315	C-N6 ESD Sextuple Nosepiece ESD Objectives
⑧	MBC91110	C-SR2S Right Handle Stage with 2SHolder
	MBL71100	C-C Abbe Condenser NA 0.9



### Option

⑨	MBB93100	C-TF Trinocular Tube F
⑩	MBB93110	C-TT Trinocular Tube T
	MBB73520	Y-TV TV Tube
	MQD42000	C-mount TV Adapter A
⑪	MBE25301	Lamphouse HMX-3B
⑫	MBF33342	Mercury Lamp Socket S 100W BL
⑬	MBE75010	C-FC Epi FL Collector Lens
⑭	MBF12321	C-SHG1 Power Supply for HG 100W
⑮	MBE75060	C-FC Epi-FL Centering Tool
⑯	MBE74100	D-FL Epi-fluorescence Attachment*

\* Up to 6 filter cubes can be attached.

- Ci set for phase contrast observation.

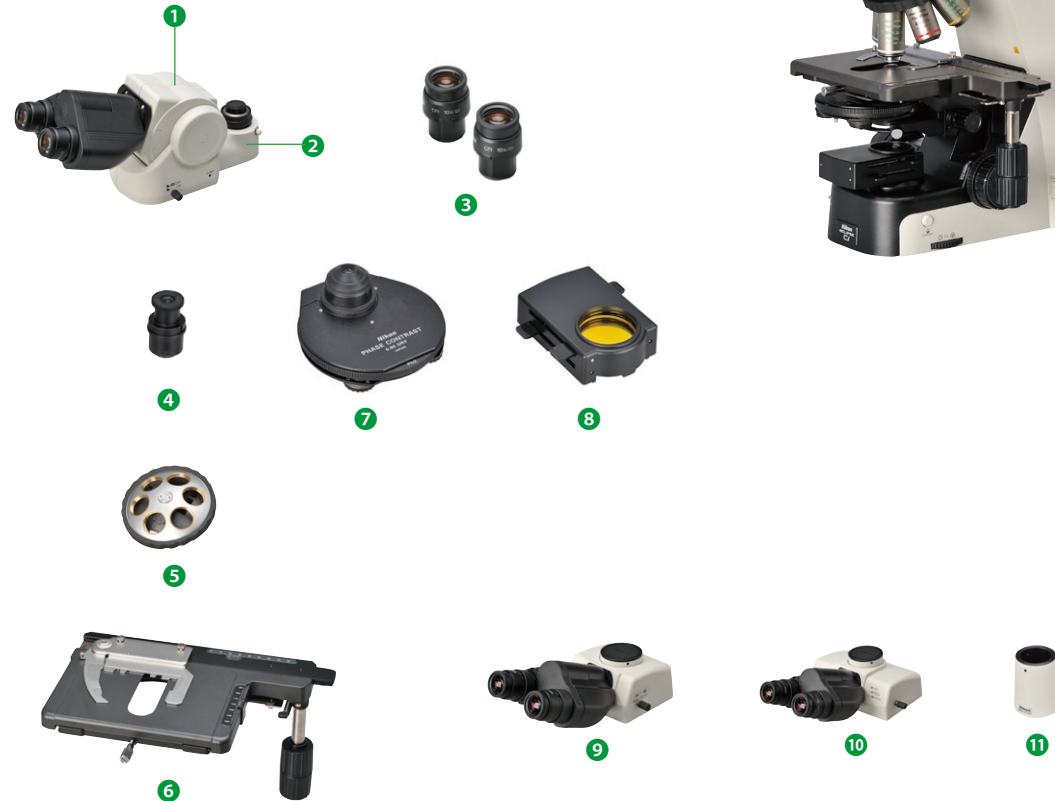

	MBA93000	ECLIPSE Ci-E Main Body
	MBA95000	ECLIPSE Ci-L Main Body
	MBA94010	ECLIPSE Ci-S Main Body
1	MBB93800	C-TE2 Ergonomic Binocular Tube
2	MBB96800	C-TEP2 DSC Port for Ergonomic Binocular Tube
3	MAK10100	CFI 10X Eyepiece (2 pcs.)
4	MAK85000	C-CT Centering Telescope with UW Adapter
5	MBP71315	C-N6 ESD Sextuple Nosepiece ESD <sup>*1</sup>
		Objectives
6	MBC91110	C-SR2S Right Handle Stage with 2SHolder
7	MBL73100	C-C Phase Contrast Turret Condenser
8	MBN97000	CI-FCH Filter Cassette Holder

Option

9	MBB93100	C-TF Trinocular Tube F
10	MBB93110	C-TT Trinocular Tube T
11	MBB73520	Y-TV TV Tube
		C-mount TV Adapter A

\*1 Not required for Ci-E microscope.

Tubes		Beam Split Ratio (Eyepiece/Upper port/Rear port)	Field Number	
1	MBB94510	NI-TT-E Morized Quadrocular Tilting Tube	100/0/0, 0/100/0, 0/0/100	22/25
2	MBB94521	NI-TT Quadrocular Tilting Tube	100/0/0, 0/100/0, 0/0/100	22/25
3	MBB92100	C-TB Binocular Tube	100/-/-	22
4	MBB93100	C-TF Trinocular Tube F	100/0/-, 0/100/-	22/25
5	MBB93110	C-TT Trinocular Tube T	100/0/-, 20/80/-, 0/100/-	22/25
	MHB43200	C-TT-C Trinocular Tube T	100/0/-, 0/100/- (for C2 Scanning Head)	22/25
6	MBB93800	C-TE2 Ergonomic Binocular Tube	100/-/0, 50/-/50	22

Ports		Magnification	
7	MBB96710	NI-RPZ-E Motorized DSC Zooming Port for Quadrocular Tube <sup>*1</sup>	0.6x - 2.0x
8	MBB96721	NI-RPZ DSC Zooming Port for Quadrocular Tube <sup>*2</sup>	0.6x - 2.0x
9	MBB96800	C-TEP2 DSC Port for Ergonomic Binocular Tube	0.7x

TV-Tube		
10	MBB94700	C-TAQ Tube Adapter for Quadrocular Tube
11	MBB73520	Y-TV TV Tube
	MBB73550	Y-TV 0.55 TV Tube

\*1 For use in combination with NI-TT-E Motorized Quadrocular Tilting Tube  
 \*2 For use in combination with both NI-TT-E Morized Quadrocular Tilting Tube and NI-TT Quadrocular Tilting Tube.



### TV-Adapter, etc.

12	MAB53410	V-T Photo Adapter
13	MQD42060	C-Mount TV Adapter 0.6X
14	MQD42040	C-Mount TV Adapter 0.45X
15	MQD51040	C-Mount TV Adapter 0.35X
16	MQD42140	C-Mount TV Adapter VM4X
17	MQD42120	C-Mount TV Adapter VM2.5X
18	MQD42000	C-Mount TV Adapter A
	MQD42070	C-Mount Adapter 0.7X
	MQD42055	C-Mount Adapter 0.55X
	MHV55070	A1-U-TT FN1/Ni Adapter (for A1 Scanning Head) <sup>*3</sup>
	MHV40100	C2-NI-TT Quadrocular Tilting Tube (for C2 Scanning Head) <sup>*3</sup>

\*3 To be used in combination with NI-TT-E Motorized Quadrocular Tilting Tube or NI-TT Quadrocular Tilting Tube

Eyepiece, etc.

	Field Number	Reticule
1 MAK10100 CFI 10X Eyepiece	22	-
2 MAK30100 CFI UW 10X Eyepiece	25	-
MAK11100 CFI 10XM Eyepiece with Photo Mask	22	Photomask
MAK31100 CFI UW 10X M Eyepiece with Photo Mask	25	Photomask
3 MAK10150 CFI 15X Eyepiece	14.5	-
4 MAK99000 CFI UW EG Eye Guard	-	-

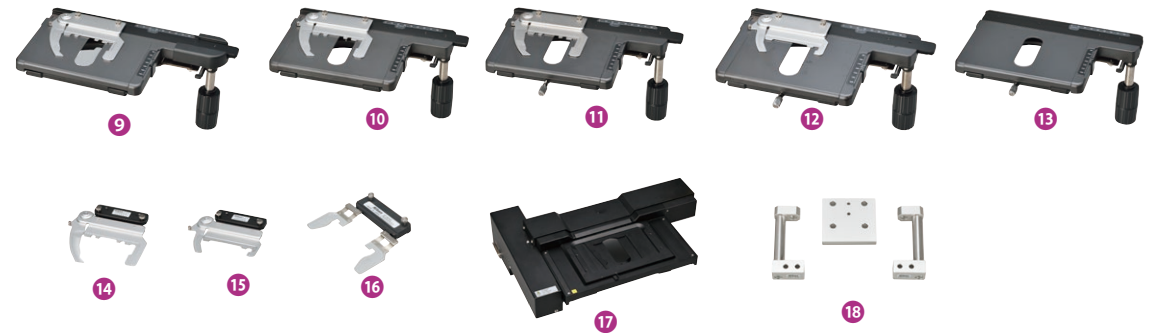

Substage

5 MBD93010	NI-SSR Substage for Rotatable /Motorized Stage
6 MBD93000	NI-SS Substage
7 MBD94000	NI-CH Condenser Holder
8 MBD93030	NI-SSF Substage for Focusing Nosepiece



Stage

9	MBC91010	NIE-CSRR2 Right Handle Rotatable Ceramic Stage with Holder
10	MBC91030	NIU-CSRR2 Right Handle Rotatable Ceramic Stage with Holder
11	MBC91110	C-SR2S Right Handle Stage with 2S Holder
12	MBC91115	C-CSR1S Right Handle Ceramic Stage with 1S Holder
13	MBC91130	C-CSR Right Handle Ceramic Stage
14	MBC95020	C-H2L Specimen Holder 2L
15	MBC95025	C-H1L Specimen Holder 1L
16	MBC90040	C-H1C Double Arm Specimen Holder
17	MBC96100	NI-S-E Motorized XY Stage
18	MBC96110	NI-SA Motorized XY Stage Adapter
19	MBF95130	NI-SJ Joystick for Motorized Stage
20	MBF95110	NI-ERG NI Ergo Controller
21	MXB22406	NI-SH-D Dish Holder
22	MBC74001	FN-3PS2 FN1 Standard Stage
23	MBC94100	NI-3PSA Adapter for FN1 Standard Stage

Condenser	NA	O.D. (mm)	Objective Magnification*
1 MBL71100 C-C Abbe Condenser NA 0.9	0.9	1.9	4x-100x
2 MBL71200 C-C Achromat Condenser NA 0.9	0.8	2.0	4x-100x
3 MBL11300 Achromat Swing-out Condenser 2-100x	0.9/0.22	1.8	2x-100x
4 MBL71500 C-C Slide Achro Condenser 2-100x	0.9	2.2	2x-100x
5 MBL71300 C-C Achromat Swing-out Condenser 1-100x	0.8/0.12	3.2	1x-100x
6 MBL71400 C-C Achromat Aplanatic Condenser	1.4	1.6	10x-100x
X LWD Condenser	0.65	10.2	4x-40x
7 MBL12010 Darkfield Condenser for X/Y (Oil)	0.8-0.95	4	20x-40x
8 MBL12000 Darkfield Condenser for X/Y (Dry)	1.2-1.43	1.5	20x-100x
9 MBL78700 D-CUO DIC Condenser Oil	1.4	1.6	10x-100X
MBL99000 NI-CUD Universal Condenser Dry	0.88	2.5	2x-100X
MBL99800 NI-CUD-E Motorized Universal Condenser Dry	0.88	2.5	2x-100X

\*F.O.V.22

### Intermediate Module

10 MBB75710 C-ER Eyelevel Riser
11 MBB74100 Y-IDP Double Port (Beam split ratio: Eyepiece/Rear Port = 55/45, 100/0)
12 MBB75500 Y-IM Magnification Module (1x, 1.25x, 1.5x, 2x)
13 MBB75400 Y-IDT Drawing Tube



10



11



12



13

### Other accessories

14 MBE49100 D-FLE Filter Cube for Reflected Illumination
15 MBE49200 D-FLD Filter Cube for Darkfield Illumination
16 MBH79000 D-ES Slider for Reflected Illumination
17 MXA22129 C-FK Fine Focus Knob
MBN91802 NI-ND2 Filter 36mm ND2 <sup>*1</sup>



14



15



16



17

\*1 For Ni only



1	MBB75100	Y-THF Teaching Unit Face to Face
2	MBB75110	Y-THS Teaching Unit Side by Side Unit B
3	MBB75120	Y-THM Main Teaching Unit
4	MBB75131	Y-THR-L Teaching Unit Side by Side Type L
5	MBB75150	Y-THSP Support for Side by Side
6	MBB75141	Y-THPL LED Pointer Unit for Teaching Head
7	MBF81001	TH-AC2 AC Adapter for TH Pointer Unit



Face-to-face



Side-by-side



Five-person type

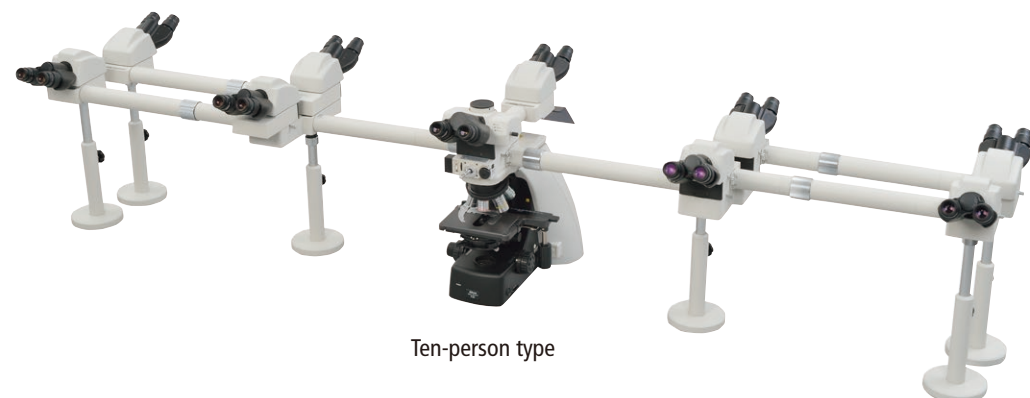

Ten-person type



**WARNING**

TO ENSURE CORRECT USAGE, READ THE CORRESPONDING  
MANUALS CAREFULLY BEFORE USING YOUR EQUIPMENT.

Company names and product names appearing in this brochure are their registered trademarks or trademarks.  
N.B. Export of the products\* in this brochure is controlled under the Japanese Foreign Exchange and Foreign Trade Law.  
Appropriate export procedure shall be required in case of export from Japan.  
\*Products: Hardware and its technical information (including software)  
Monitor images are simulated.

Specifications and equipment are subject to change without any notice or obligation on the part  
of the manufacturer. April 2013 ©2013 NIKON CORPORATION

**NIKON CORPORATION**

Shinagawa Intercity Tower C, 2-15-3, Konan, Minato-ku, Tokyo 108-6290, Japan  
phone: +81-3-6433-3705 fax: +81-3-6433-3785  
<http://www.nikon.com/products/microscope-solutions/>

ISO 14001 Certified  
for NIKON CORPORATION

**NIKON INSTRUMENTS INC.**

1300 Walt Whitman Road, Melville, N.Y. 11747-3064, U.S.A.  
phone: +1-631-547-8500; +1-800-52-NIKON (within the U.S.A. only)  
fax: +1-631-547-0306  
<http://www.nikoninstruments.com/>

**NIKON INSTRUMENTS EUROPE B.V.**

Tripolis 100, Burgerweeshuispad 101, 1076 ER Amsterdam, The Netherlands  
phone: +31-20-7099-000 fax: +31-20-7099-298  
<http://www.nikoninstruments.eu/>

**NIKON INSTRUMENTS (SHANGHAI) CO., LTD.**

CHINA phone: +86-21-6841-2050 fax: +86-21-6841-2060  
(Beijing branch) phone: +86-10-5831-2028 fax: +86-10-5831-2026  
(Guangzhou branch) phone: +86-20-3882-0550 fax: +86-20-3882-0580

**NIKON CANADA INC.**

CANADA phone: +1-905-602-9676 fax: +1-905-602-9953

**NIKON FRANCE S.A.S.**

FRANCE phone: +33-1-4516-45-16 fax: +33-1-4516-45-55

**NIKON GMBH**

GERMANY phone: +49-211-941-42-20 fax: +49-211-941-43-22

**NIKON INSTRUMENTS S.p.A.**

ITALY phone: +39-55-300-96-01 fax: +39-55-30-09-93

**NIKON GMBH SWITZERLAND**

SWITZERLAND phone: +41-43-277-28-67 fax: +41-43-277-28-61

**NIKON UK LTD.**

UNITED KINGDOM phone: +44-208-247-1717 fax: +44-208-541-4584

**NIKON CEE GMBH**

AUSTRIA phone: +43-1-972-6111 fax: +43-1-972-611-140

**NIKON SINGAPORE PTE LTD**

SINGAPORE phone: +65-6559-3651 fax: +65-6559-3668

**NIKON INSTRUMENTS KOREA CO., LTD.**

KOREA phone: +82-2-2186-8400 fax: +82-2-555-4415